

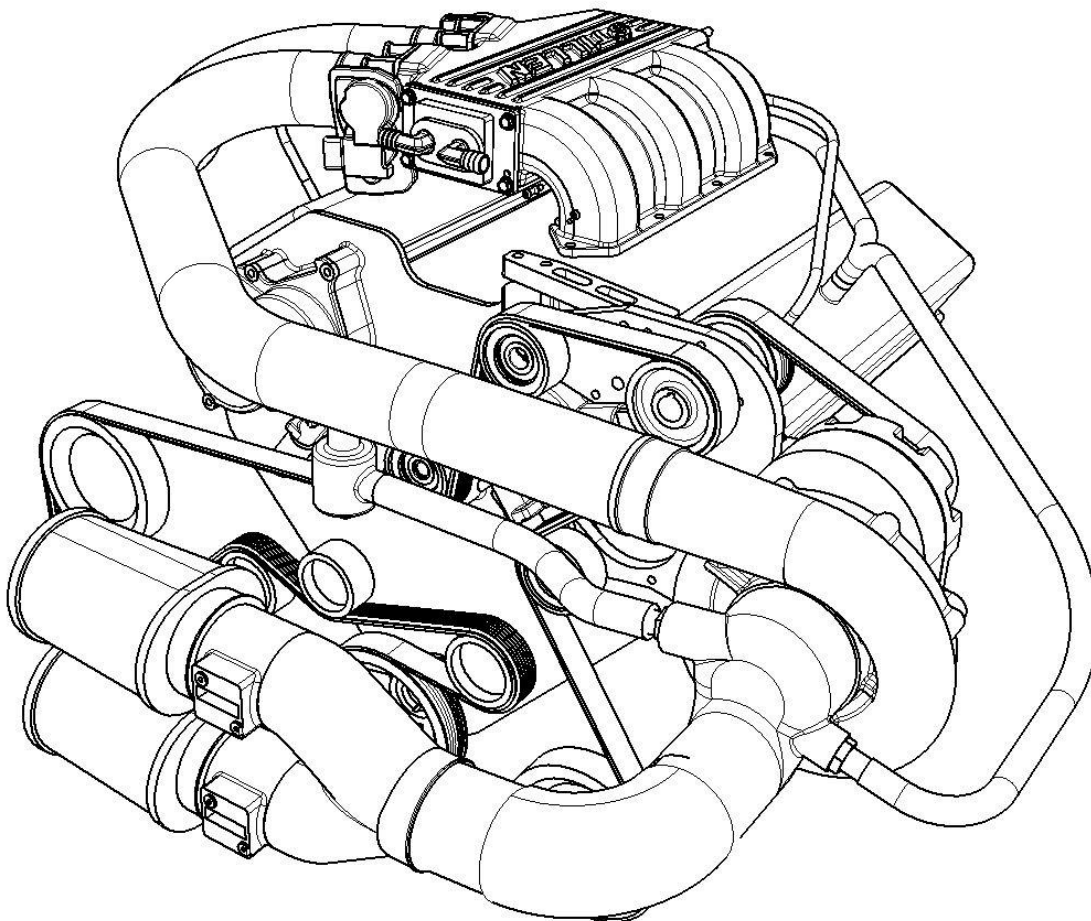

NISSAN 370Z

INTERCOOLED SUPERCHARGER INSTALLATION INSTRUCTIONS

407770/407770P



2010 STEVE MILLEN SPORTPARTS, INC.

All rights reserved. No part of this publication may be reproduced, transcribed, transmitted, or translated into another language in any form, by any means without written permission of STEVE MILLEN SPORTPARTS, INC.

Congratulations...

on your purchasing the *STILLEN* supercharger system for your 370Z

For the smoothest installation and best performance and reliability from your supercharger, please follow these simple points.

- Read all the instructions to familiarize yourself with various parts and operations. A list of supplied parts is located on the back pages of these instructions.
- Check the oil in your supercharger every 2,500 miles. The initial fluid change should be done 2,500 miles after install and then every 7,500 miles
- Some parts on the list are already assembled, torqued and sealed, **DO NOT DISASSEMBLE UNLESS INSTRUCTED TO DO SO.** If any parts are missing or damaged, please call us immediately.
- Gather all required tools and supplies before starting installation.
- **Use 91 octane or higher fuel.** Fuel quality will vary depending on manufacturer, always use quality fuel.
- This kit is designed for stock engines. If the engine is modified in any way, contact STILLEN to discuss any conflicts or issues that could affect the superchargers performance.
- Aftermarket re-calibration devices that modify the fuel or spark curve are not recommended and may cause engine damage or failure.
- This STILLEN supercharger system is intended to be installed on a well maintained, healthy engine. We do not recommend installing this system on a sick or damaged engine, this can result in premature engine failure and possible supercharger failure. **Stillen is not responsible for damages due to improper installation or damages due to installation on worn or damaged engines.**
- Do **not** alter, modify, or adjust the STILLEN supercharger system in any way, shape or form. Unauthorized changes to boost levels, electronics or any other system will **void** warranties and can cause catastrophic damage. If this system is being installed on a new vehicle it is very important that factory break-in procedures are followed to prevent any adverse affect on the vehicle.

EXTREMELY IMPORTANT:

To insure maximum performance and safety, boost pressure **MUST** be checked immediately after install. We recommend using a **quality** (Snap-On, AEM, HKS etc) calibrated boost/pressure gauge that reads 10-15psi (1 BAR) maximum if analog or a digital gauge. The gauge must be **"T"**eed into the small front vacuum line that leads to the supercharger bypass valve. Maximum boost reading will be obtained at WOT in 3rd gear @ 7000 rpm. We suggest you avoid hitting the RPM limiter or an incorrect reading will result. A dynamometer can be used if traffic conditions or an "off road" location is not available for proper testing.

The boost reading should be from 7.6-8.4 psi. Pressure can vary due to atmospheric conditions and dyno types. For example a Dynojet dyno boost reading will be .3-.4 low as compared to actual road testing. Make sure to do 2-3 tests and write down your results to confirm an accurate reading. If outside the recommended pressure readings please contact Stillen technical support immediately for further assistance



WARNING:

WE STRONGLY URGE THAT YOU REFER THIS INSTALLATION TO AN ASE CERTIFIED MECHANIC WITH EXPERIENCE IN THIS TYPE OF INSTALLATION. FAILURE TO DO SO COULD LIMIT YOUR TECH SUPPORT AND AFFECT YOUR WARRANTY.

YOU NEED TO MAKE SURE YOU HAVE THE TUNE FOR YOUR VEHICLE BEFORE INSTALLING THE SUPERCHARGER! !READ THE PROVIDED ECU PROGRAMMING INSTRUCTIONS ON HOW TO CHECK THIS!!

IF YOU HAVE NOT DONE SO ALREADY, REMOVE THE TWO RECTANGULAR SHIPPING BRACES FROM THE LOWER PORTION OF THE BLOWER ASSEMBLY. THE SUPERCHARGER WILL NOT FIT ON THE VEHICLE WITH THEM IN PLACE.

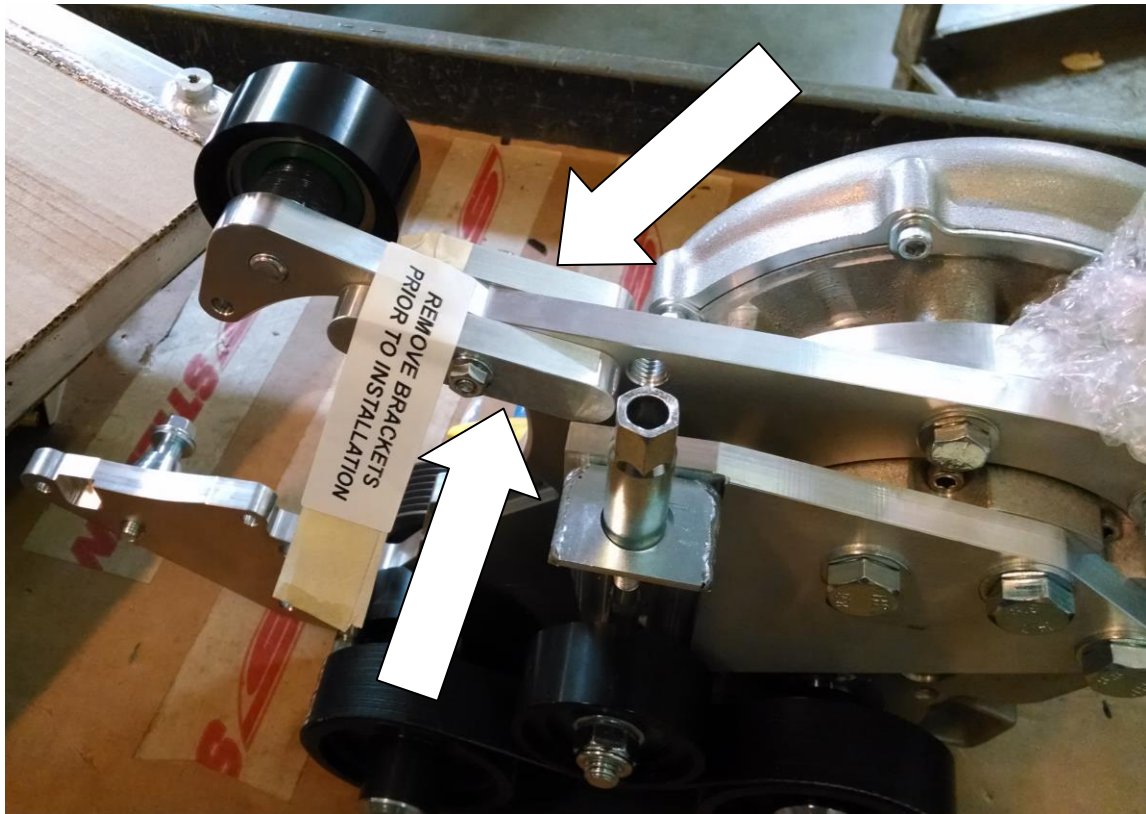

FUEL PUMP INSTALL

Caution: Never work on an open fuel system in an enclosed area. Always have adequate ventilation and be in an area with no open flames or sparks, and NO SMOKING.

The fuel system is under pressure, use appropriate safety precautions when disconnecting the fuel system!

1. Disconnect the battery.
2. The fuel pump is accessed from behind the passenger seat. Remove the carpet covered panel. (photo 1)
3. Remove the nuts on the cover plate and lift out of the way. (photo 2)

4. Unplug the connector and fuel line. Remove the screws securing the assembly to the tank. (photo 3)

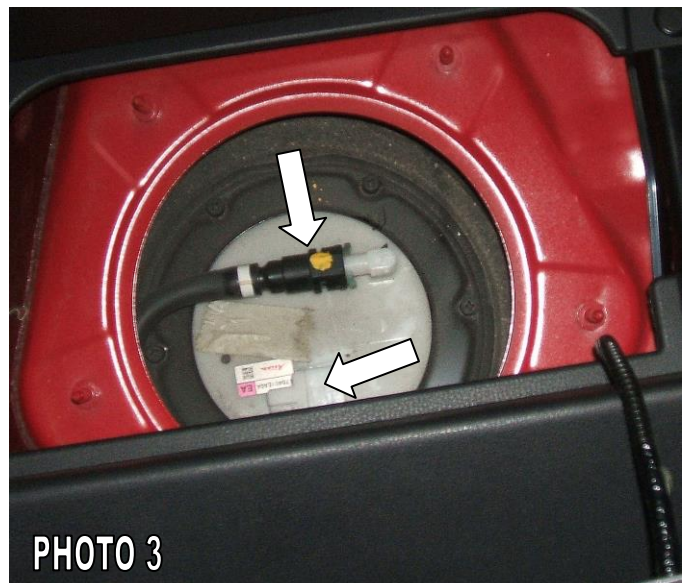
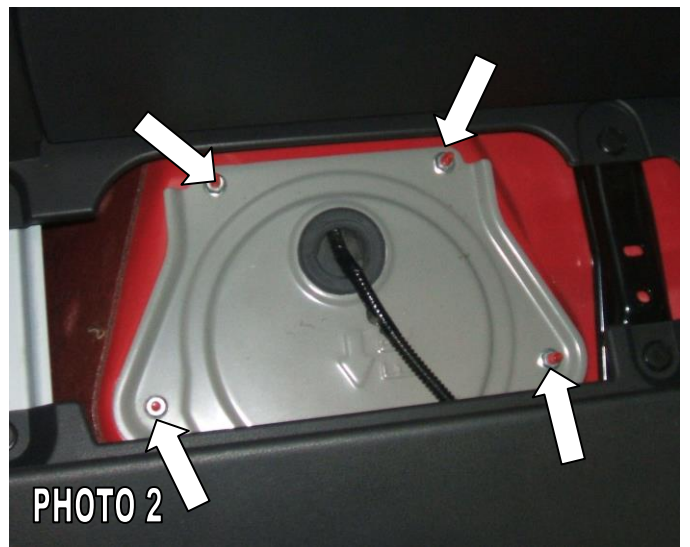
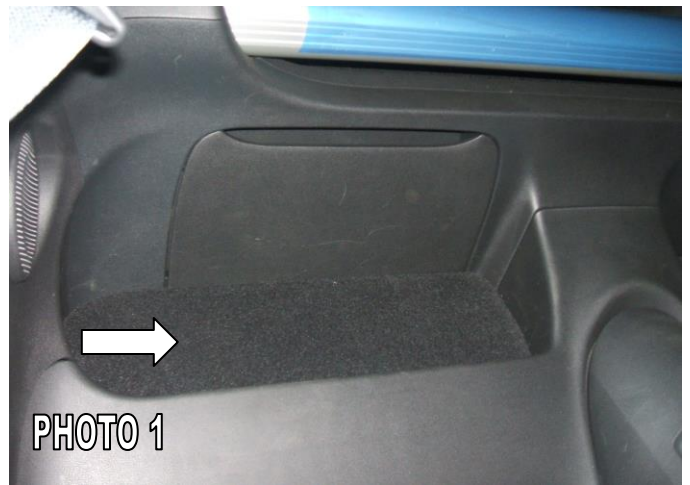

- Carefully lift out the fuel pump housing assembly. Disconnect the saddle tank crossover tube. Be careful not to bend the float arm. (photo 4)

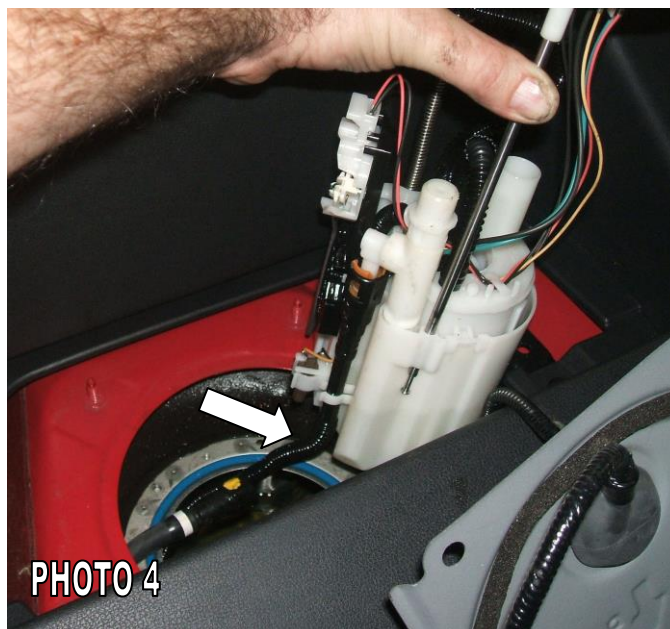

- On a clean work bench, unplug the fuel pump. Unclip the sending unit and slide it out of its mount. Unclip the fuel temp probe. Remove the retainer clip in the metal shaft that has the spring and separate the upper and lower assemblies. (photo 5) Remove the spring and spacer and set aside.

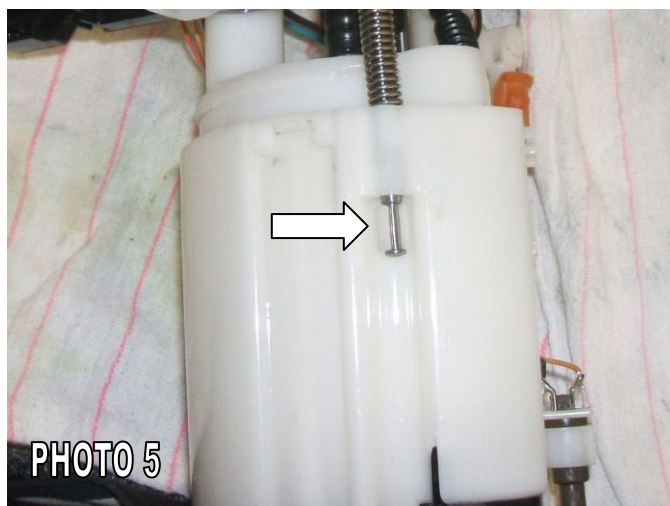

- Unclip and remove the lower bucket.

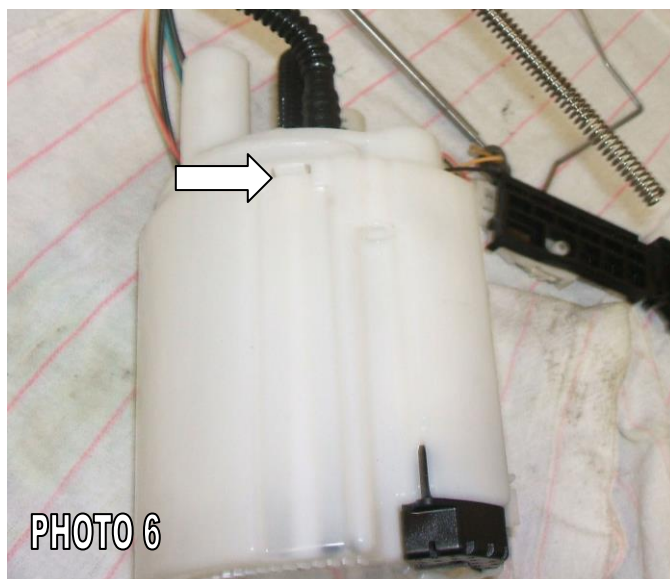

8. Remove the fuel line that runs from the pump to the housing. Remove the pump by turning it and pulling it out from the bottom. Remove the pickup screen from the pump. The screen will be reused.
9. In the bore that the fuel pump sits in, you will see a thin, plastic ring that the pump locks into. Using a rotary tool or die grinder, grind the 2 tabs flush with the ring. (photo 7)

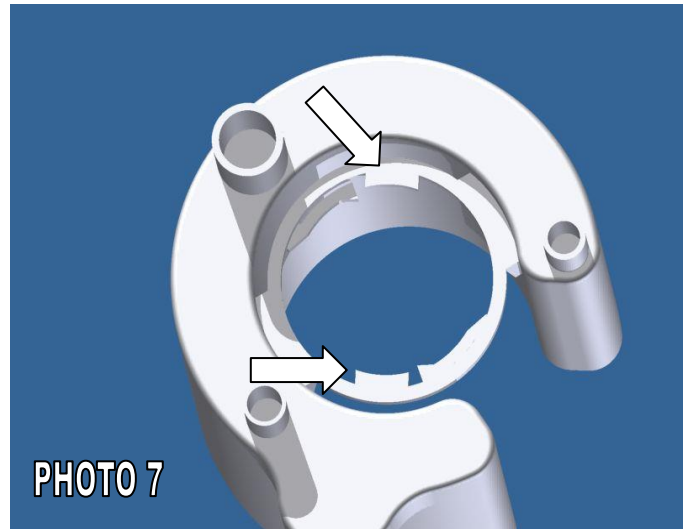

10. On the supplied fuel pump, make sure the 4 tabs on the bottom have been filed off. If not, file them flush

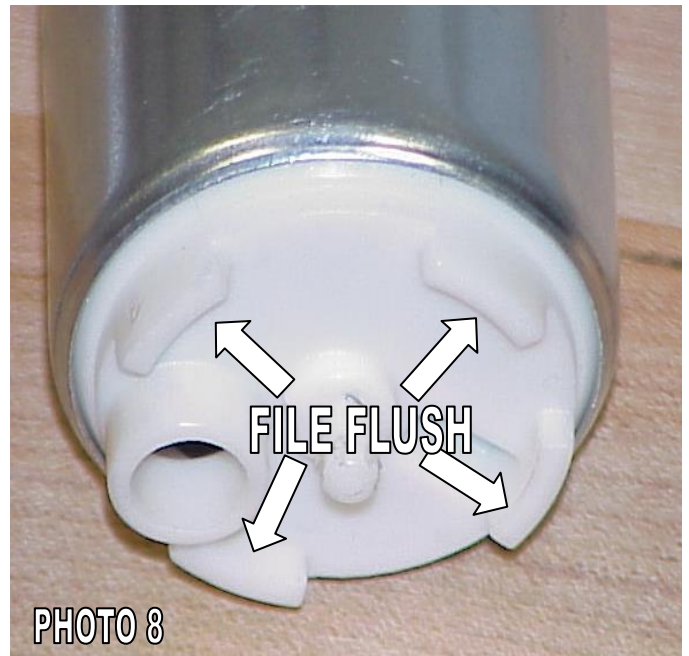

11. Insert the new pump into the assembly. It may be necessary to file the ring a little more to allow the top of the pump to slide into the ring.



12. On the bottom of the lower bucket, you will see a small swirl jet. Using a screwdriver, CAREFULLY pry this valve up. It only needs to come up enough to be able to drill the hole in the tip. It is important to note that it is thin plastic and can break easily. **NO REPLACEMENT PARTS ARE AVAILABLE FOR THE FUEL PUMP ASSEMBLY.**

13. Using the supplied #50 drill (smallest), carefully drill the jet larger. **DO NOT DRILL THROUGH THE OTHER SIDE!** Clean out the jet and push it back down into the lower bucket. (photo 10)

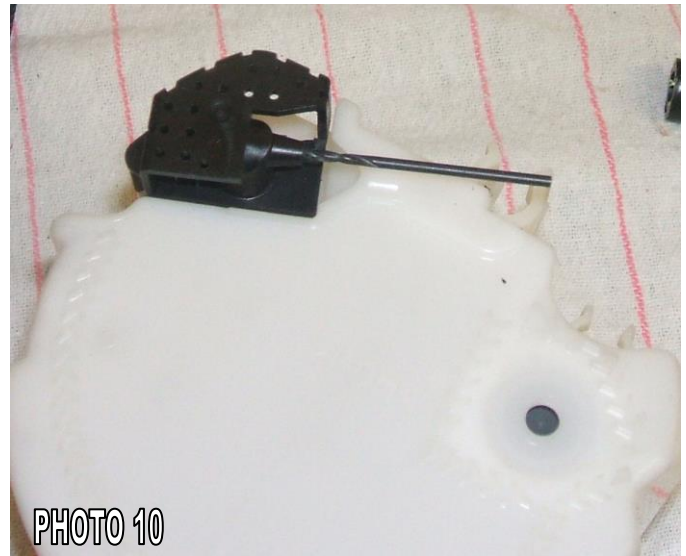

14. On the side of the main assembly is the silver pressure regulator. It can not be removed from the housing and must be drilled in place. (photo 11)

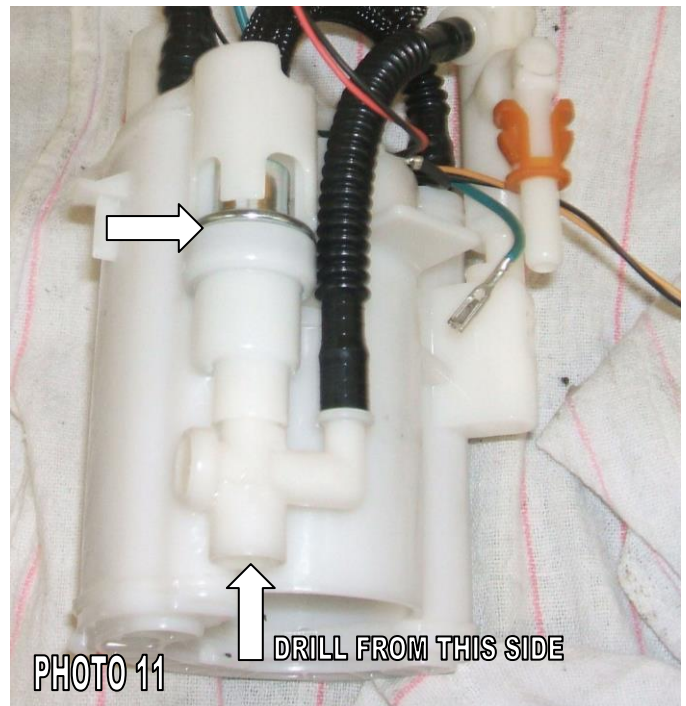

15. Using the 7/16 (larger) drill bit, carefully drill the opening in the tip (on the bottom of the regulator) larger. **DO NOT DRILL TOO DEEP OR YOU WILL RUIN THE REGULATOR! YOU ARE JUST DRILLING THE TIP.** Clean out any metal shavings.

(photo 12 shows the regulator removed to show it more clearly)



16. On the pickup screen, you will need to file the tube that fits over the pump inlet port flush with the 2 support ribs. Clean out any plastic shavings and install it onto the bottom of the new pump.
(photo 13)

17. Reinstall the lower bucket making sure that both clips are in securely.

18. Install the new fuel hose and secure with hose clamps. **ONLY USE THE 12" SECTION OF SUBMERSIBLE FUEL LINE THAT WAS SUPPLIED WITH THE PUMP.** You will need to cut it a little shorter. Make sure it does not kink.

19. Reassemble the upper and lower halves of the assembly. Make sure the spring spacer and spring are installed on the same rod that they came off of. Install the retainer clip.

20. Reinstall level sensor and clip the temp sensor back in place.

21. Cut off the pump connectors and install the new connector using the supplied crimp connectors.(photo 14)

22. Reinstall the pump assembly into the car. Be sure the large seal is in place and the tube for the saddle tank is attached. Install the locking ring.

23. Attach the fuel line and connector. Install the cover and install the panel.

24. Reconnect the battery and start the vehicle to make sure everything is working. Shut off the vehicle.

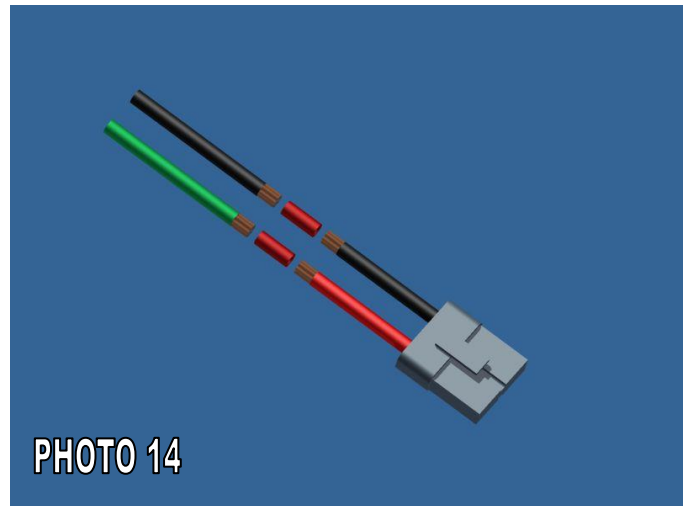

REMOVING STRUT TOWER BAR, AIR BOXES & FASCIA

1. Disconnect the negative battery cable. Remove the strut tower bar and engine cover and set aside. (The rear STB bolts are under the center cowl cover) The strut tower bar will be reused.(photo 15)
2. Unplug the Mass Airflow Sensors (MAS) and unclip the wire from the air boxes.(photo 16)
3. Loosen the clamp on the intake tube where it attaches at the throttle body and remove the bolt that holds the air box in using a 10mm socket. Remove the small hose clamp connecting the breather tube to the intake tube. Remove complete intake as 1 piece. It will require a firm tug to release it from the rubber grommets on the bottom.
4. Remove numerous plastic clips and bolts on the forward radiator cover. Set the cover out of the way.
5. Remove Fascia. This will require removing the bolts from the lower engine cover. You will also have to remove the plastic clips from the front wheel well liners to reach the bolts under very end of the fascia. After removing all the hardware, firmly pull the fascia out of the clips around the headlights and pull the fascia away from the vehicle. Set out of the way.
6. Remove foam fascia support piece by pulling it straight forward. Set out of the way.
7. Unbolt the brace in photo 17 and allow it to hang on the front bumper brace.

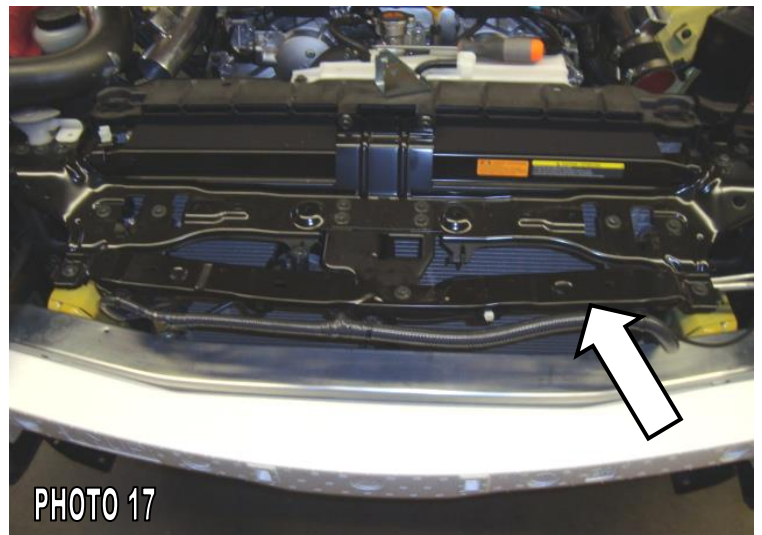
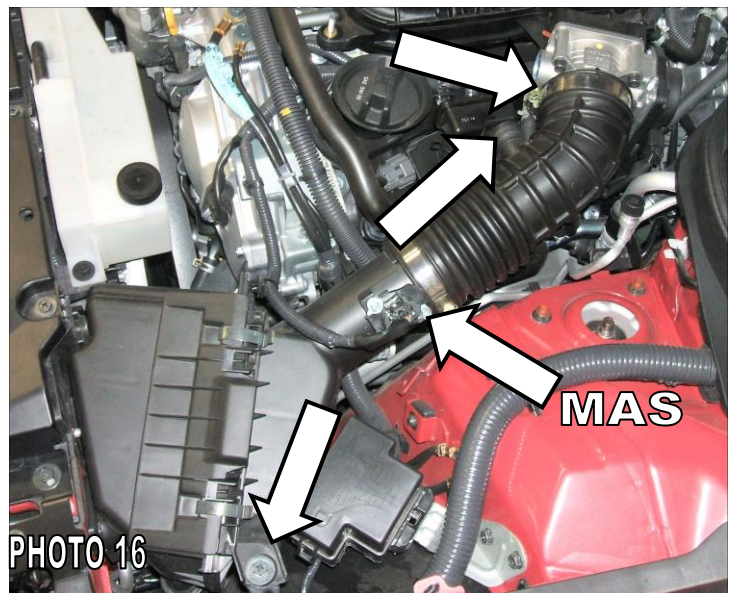
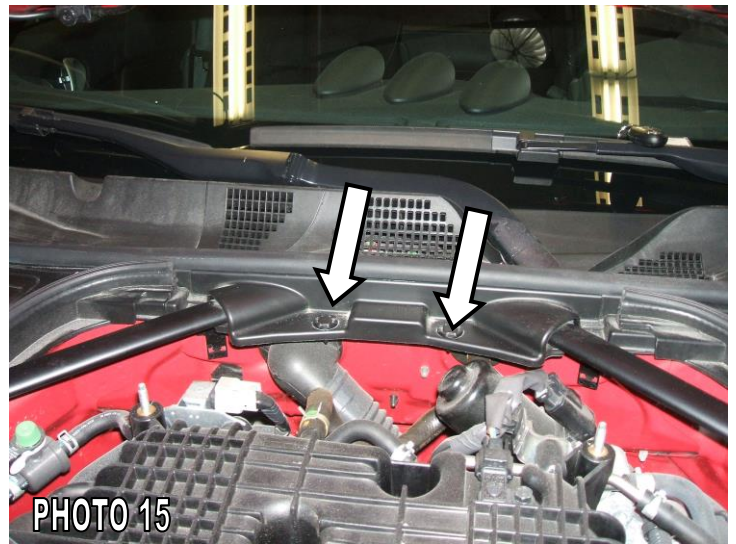

8. **NISMO ONLY:** You will need to remove the air deflectors on the front bumper. See photo 18. Do this by drilling out the rivets. These will not be reused.
9. Next you will need to make a clearance notch on the driver side upper corner of the strut tower bar. This is needed to clear the heat exchanger overflow tank. See photo 19
10. You will also need to remove the front stabilizer bar and set aside. This will not be reused. Reinstall the bolts. This is needed in order to clear the heat exchanger.

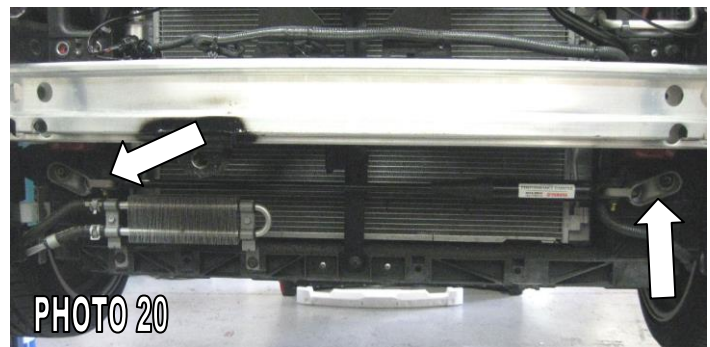
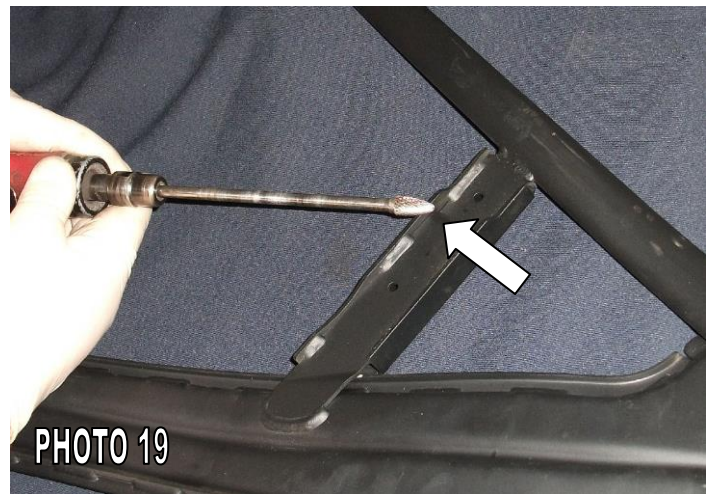
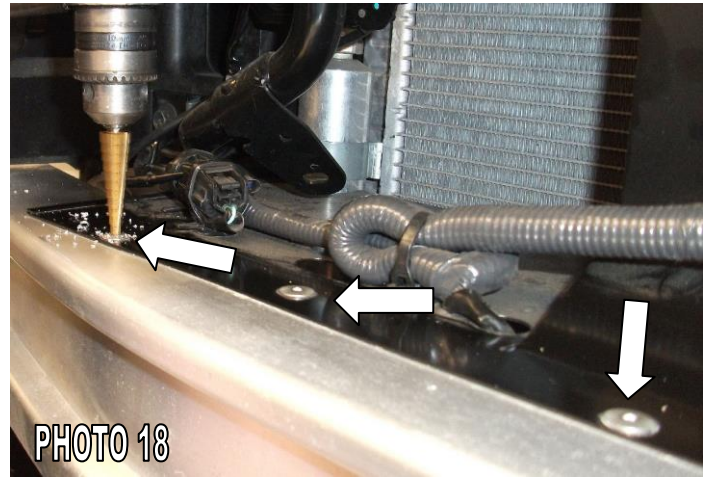

ENGINE DISASSEMBLY

1. Unplug the throttle bodies, purge valve and map sensors. disconnect the vacuum and water lines that run to the plenum. Leave the metal vacuum tree attached to the plenum. Remove the bolts and nuts holding the plenum to the lower intake manifold and lift the plenum out of the car.
2. Remove the 2 studs in the lower manifold
3. Cover the tower manifold with a towel to keep items from falling down into the runners.
4. Remove the 3 sheet metal brackets on the top of the timing cover.
5. Remove the radiator overflow bottle and hoses.
6. Cut off the 2 plastic overflow bottle mounting tabs flush with the core support.

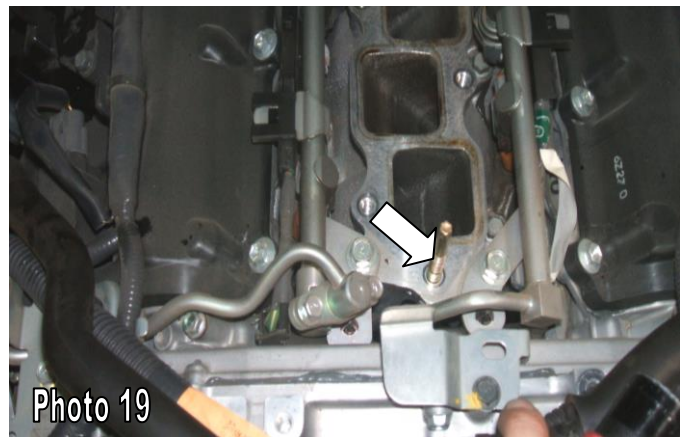
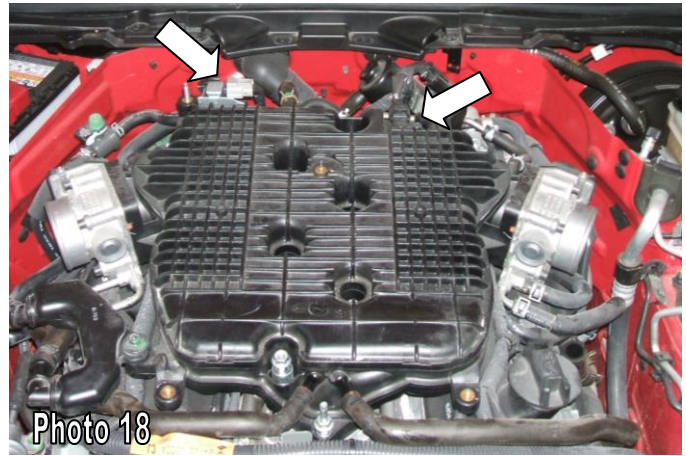

7. Using a pair of pliers, bend the lower water line back until it is clear of the belt line. You will need to cut the rubber line a little shorter.

Note: Not all vehicles have this tube.

8. Using a 3/8 drive ratchet, release the tension from the drive belt and insert an Allen wrench or bolt into the locking holes to lock it in place. Remove the belt.

9. Remove the 7 rib idler in photo 17. Keep it as it will be installed onto the supercharger assembly later.

10. Unclip the wires that are attached to the dipstick tube. Unbolt the dipstick tube and pull out the dipstick tube. Push the wires back and reinstall the tube with the wires behind it.

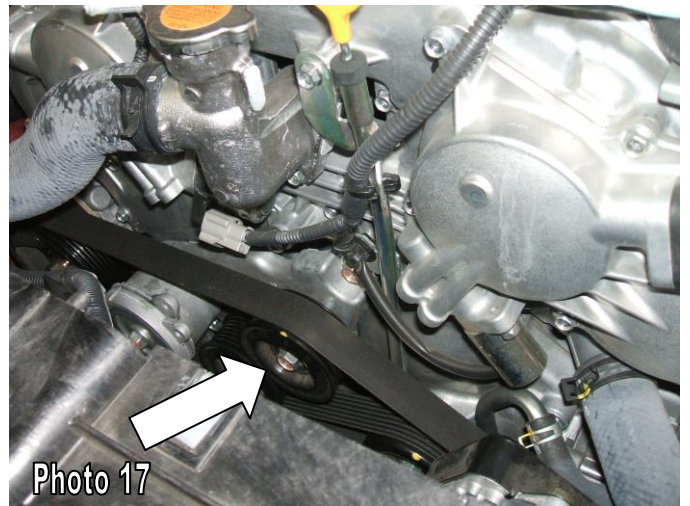
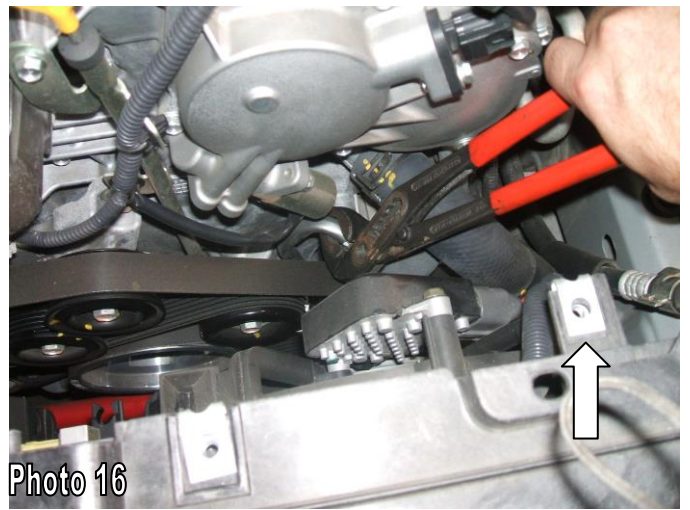

INJECTOR REPLACEMENT

1. Remove the 4 bolts on the fuel feed tube as well as the 1 holding it to the timing case. Pull the tube out.
2. Remove the 4 bolts holding the fuel rails to the lower intake manifold. Unplug the connector on the rear of the drivers side fuel rail and lift the rails out.
3. Unplug the fuel injectors, remove the retainers and pull out the injectors.
4. Using the grease supplied with the injectors, grease the o-rings and install the new injectors in place of the stock ones and plug them in. You will not be reusing the retainer clips.
5. Reinstall the injector rails and reconnect the plug on the back. Install the 2 bolts on the passenger side but do not install the drivers side bolts until after the manifold is installed.

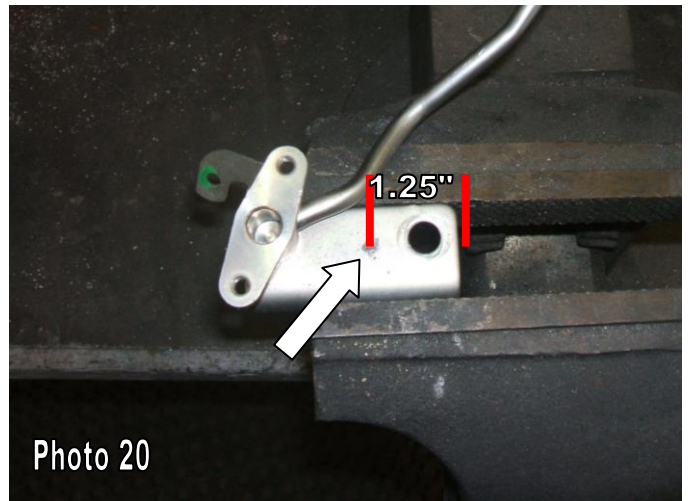
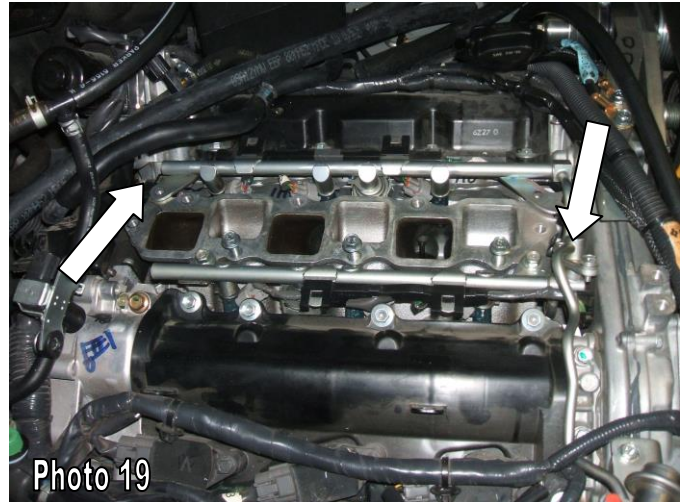

6. On the fuel feed tube, you will drill a new mounting hole as in photo 20. The hole will be centered on the bracket and 1.25" from the end. Lightly grease the o-rings and reinstall the tube and bolts. Gently bend the fuel tube until you can reinstall the mounting bolt through the new hole.



PLENUM INSTALLATION

1. Transfer the large gasket from the lower flange on the stock plenum to the groove in the new plenum.



Photo 22

2. Transfer the MAP sensor from the top of the stock plenum to the back of the new plenum. Transfer the purge valve to the new manifold.



Photo 23



Photo 24

3. Install 3 of the supplied flange bolts into the passenger side of the lower intake manifold. These bolts will need to stay above the mounting surface by about 1/2". This will allow you to install the new plenum by slipping it under the bolts and over the top of the drivers side fuel rail.



Photo 25

4. Unclip the wire harness on both valve cover. Using a pair of side cutters, cut off the 4 tabs that held the wire harness.

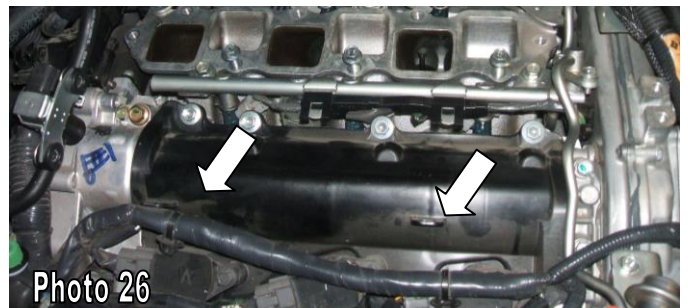

Photo 26

5. After you have slipped the manifold under the 3 bolts, start the rest of the bolts around the manifold but **DO NOT TIGHTEN THEM YET**. Using the supplied 12mm long wrench, snug down the 3 bolts under the manifold. You will have to put a small bend in the end of the wrench to reach over the fuel rails. Photo 27



6. Tighten down the rest of the bolts to **10-12 ft-lbs** then tighten the 3 bolts under the plenum to approx. the same torque.
7. Reinstall the 2 bolts on the drivers side fuel rail. Plug in the MAP sensor and purge valve. You will have to remove some tape from the harness and pull out some extra wire.



8. Install the supplied, square cut o-rings into the grooves in the throttle body mounting faces. Transfer the throttle bodies from the stock plenum to the new plenum reusing the stock mounting bolts. You will need to twist the 90° fitting down using a pair of pliers in order to attach the water lines. (photo 29) You will need to gently bend the fuel line in order to clear the connector. Plug in the connector for the rear throttle body.

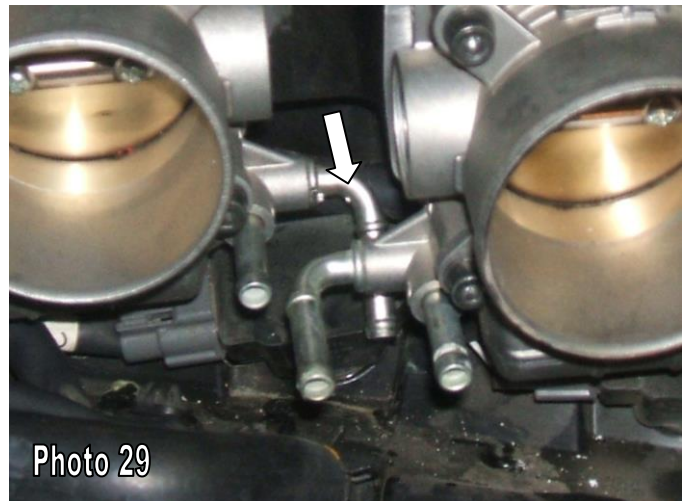

9. You will now install the throttle body extension harness. It measures approximately 17" in length. Connect to the engine harness on the driver's side and route along the front of the engine to the relocated throttle body. Ensure the connectors are fully engaged and locked together. Secure to the wire loom located at the front of the engine

10. Attach the stock water line from the back of the engine to the straight tube on the rear throttle body. Using a new section of 3/8 hose, connect the 90° fitting on the rear throttle body to the 90° fitting on the front throttle body. Then run a long piece of 3/8 line from the straight fitting on the front throttle body, around the back of the engine to the supply line mounting point on the drivers

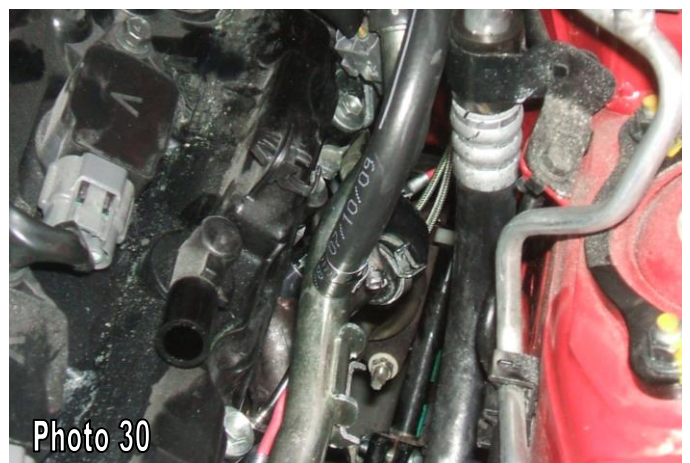

side. Secure all lines with hose clamps.

IDLER MOUNTING

1. Remove the 3 bolts in photo. They will not be reused.

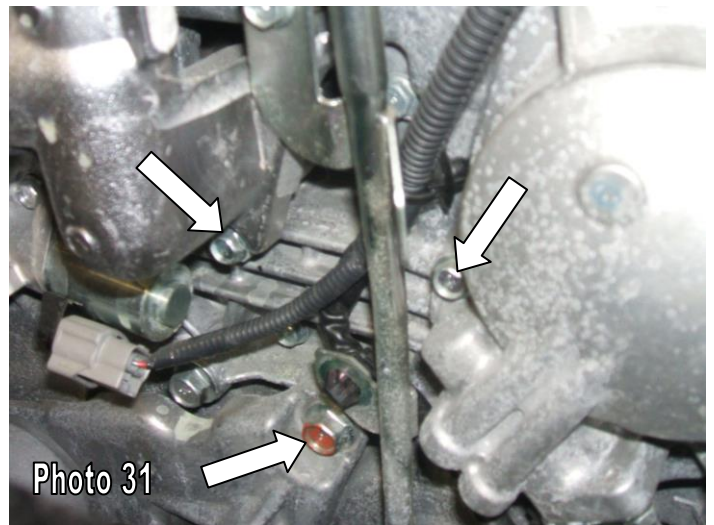

2. Install the Idler assembly using the supplied bolts. The long 6mm bolt will go in the hole under the coolant inlet neck. Make sure the idler plate is sitting flat before tightening bolts.
3. Tighten the center bolt holding on the idler.
4. Using a pair of pliers, bend the upper harness clip mounting tab, on the dipstick tube, back to clear the belt.



SUPERCHARGER MOUNTING

1. Remove the 2 air ducts by squeezing the 2 plastic clips and push the ducts back. It may take some finagling to get the ducts out of the car. These will not be reused.
2. Start by rounding out and enlarging the air box inlet hole on the drivers side.

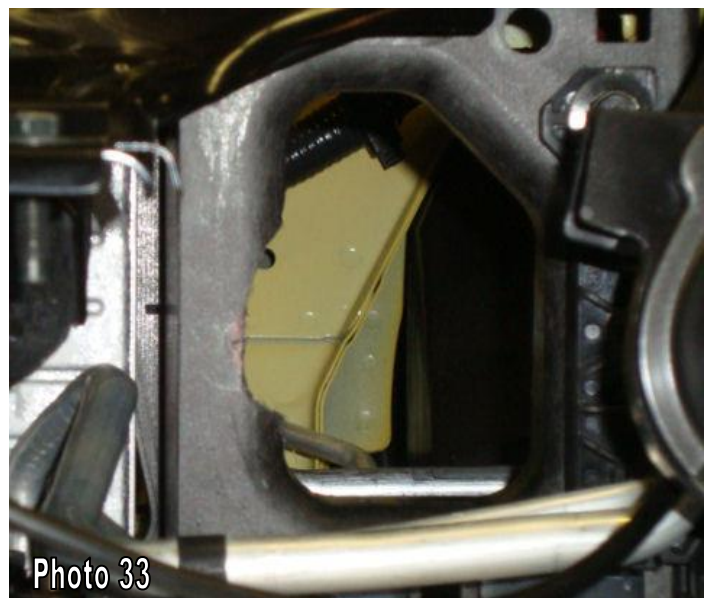

3. Remove the 5 bolts on the timing cover and the 2 bolts holding the grounding wires on the top of the timing cover.

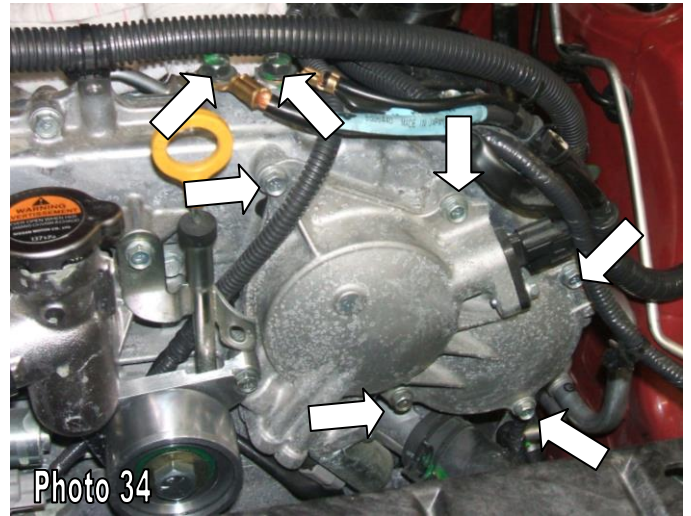

4. Remove the relay box and hang it up out of the way. Unbolt the bracket.



5. You will need to elongate the holes by about 1/4" in the direction of the arrows. This will allow you to slide the relay box over slightly when reinstalled to provide some more clearance for the blower when it is reinstalled. Do not reinstall the bracket yet.



6. Install the inlet boot into the hole from the engine compartment. Just leave it loose in there for now. (photo 37)



- Lower the blower assembly into the car. Make sure you are clear of all the lines and hoses. Using a screwdriver, mount the inlet tube onto the inlet of the blower. You will have to adjust the inlet tube to allow the blower plate to meet up with the timing cover and keep the inlet boot from kinking. Route the drain line on the bottom of the blower down to the lower pan so it is easy to access for changing the oil.

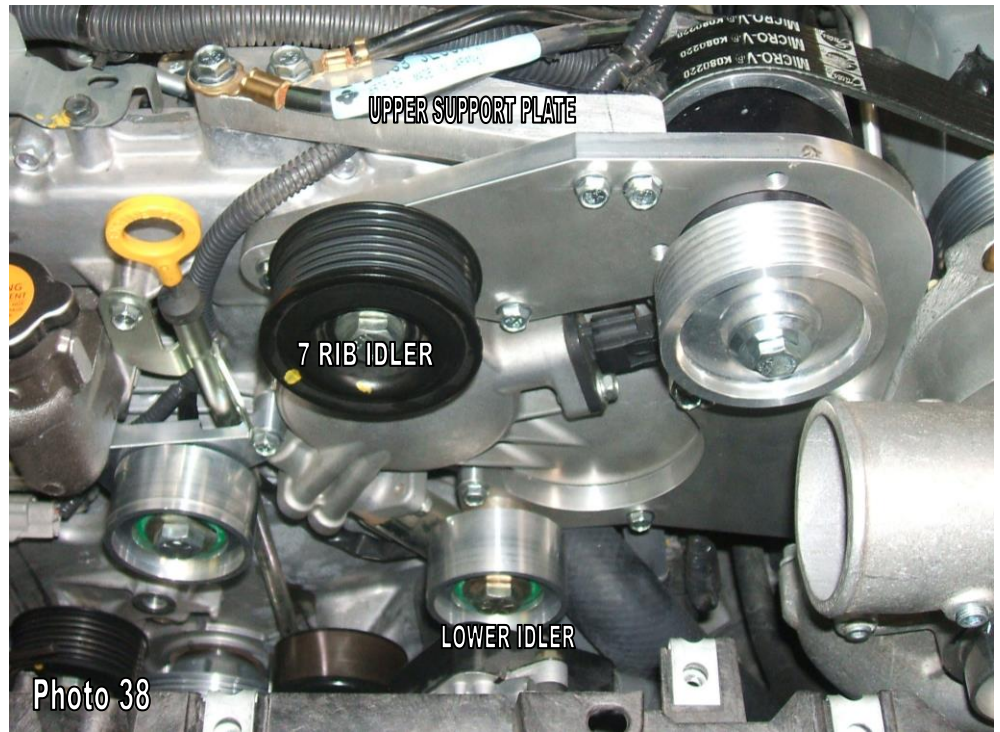

- Using the supplied bolts, mount the blower plate to the timing cover. You will have to remove the lower idler to insert the mounting bolts. Make sure you are not pinching any of the wire harness and make sure it sits flush and tighten the bolts.
- Install the upper support plate by mounting it to the supercharger plate and to the top of the timing case. (photo 38) Don't forget the ground wires on the top 2 bolts. Tighten the belt on the back of the supercharger.
- Install the #56 hose clamp to hold the inlet boot to the supercharger.
- Install the 7 rib idler removed earlier onto the blower plate using the supplied spacer and hardware. Reinstall the lower idler. (photo 38)
- Reinstall the relay box with the modified bracket and slide it away from the supercharger. (photo 39)
- You can now install the new belt per the new routing diagram. Release the tensioned and remove the Allen wrench or bolt you had holding the tensioned locked.

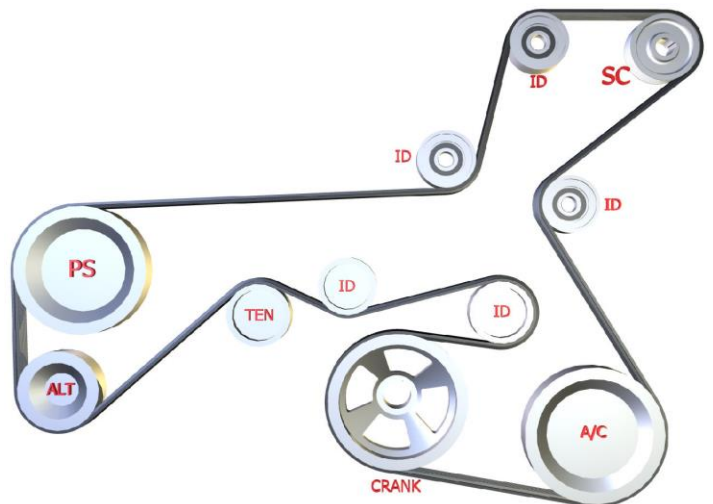

14. Check the tube you bent earlier (pg. 10 step 7) to make sure it is clear of the belt.

OVERFLOW BOTTLE MOUNTING.

1. Mount the bracket to the air box bracket on the passengers side reusing the stock bolt.
2. Slide the bottle down into the clip of the bracket. You may have to push one of the power steering lines out of the way.



3. Using a pair of pliers, gently bend the overflow nipple down and pointed in the same general direction of the upper radiator hose.



4. Install the supplied piece of hose from the overflow nipple to the overflow bottle. Make sure to hook it up to the side of the cap that has the tube that reaches to the bottom of the bottle. You can reuse the stock hose clamps.



INTERCOOLER INSTALLATION

1. First you will be mounting the pump. The pump is mounted to the bracket using 2 Adel clamps. In front of the drivers wheel well there is an open area. Remove the lower air box baffle and bracket. You may have to temporarily remove the horn to have more room to work.
2. Hold the pump bracket up to the sheet metal and mark the mounting holes. Using a drill, drill 2 pilot holes. Hold the pump bracket up and install using the supplied self-drilling screws. Reinstall the horn if removed.
3. Next is the tank. Install one of the 5/8" to 3/4" dual ID hoses to the fitting on the bottom of the tank and secure it with a hose clamp. Feed the 3/4" end under the blower to the top of the pump and secure that end with a clamp. Mount the tank to the 2 holes in the sheet metal surrounding the master cylinder compartment.
4. Install the second dual-id hose with the 3/4" end onto the outlet side of the pump and secure with a clamp. Route this line around the core support and in front of the radiator. Leave it there for now.
5. Using one of the 5/8" hoses with the 90° ends, attach the 90° end to the end of the intercooler tank and attach the other end to the intercooler that is mounted inside the plenum. You will have to route it and cut it to length and secure it with clamps.
6. Install one of the other 90° hoses to the other side of the intercooler and secure with a clamp. Route it down under the new radiator overflow tank, through the air box inlet hole, and out in front of the radiator. Leave it there for now.



7. Mount the heat exchanger to the passengers side in front of the radiator. Use the self drilling screws to mount it.

8. Attach the hoses to the heat exchanger and secure with hose clamps. your routing should be like the diagram.

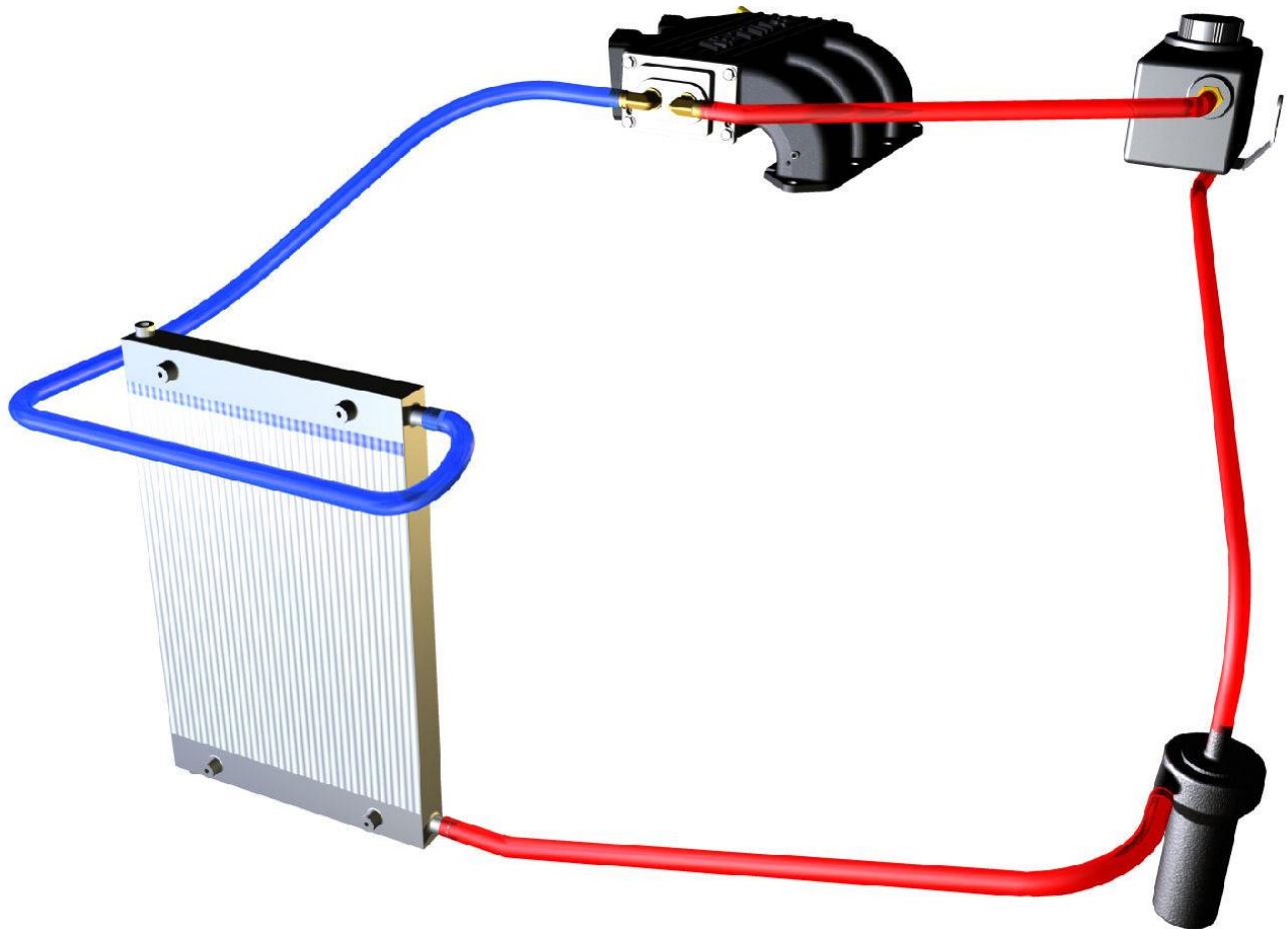

9. Mount the relay inside the master cylinder compartment. Wire the relay per the wire diagram. Route the main power supply wire and the switched wire under the cowl and to the battery compartment.



Photo 47

10. Remove the passengers side of the cowl, unclip the fuse box, and lift it out. Remove the cover.

11. You will attach the switched power wire to the wire in photo.

12. Reassemble the fuse box, reinstall it and reinstall the cowl.

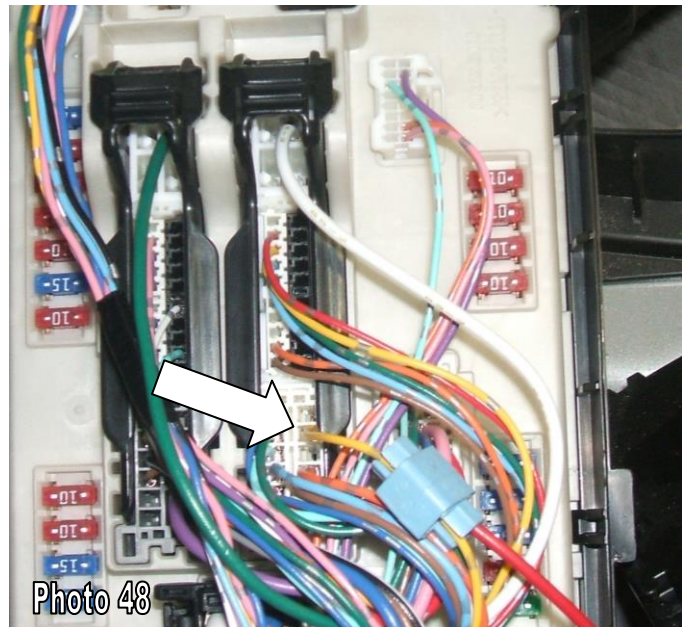
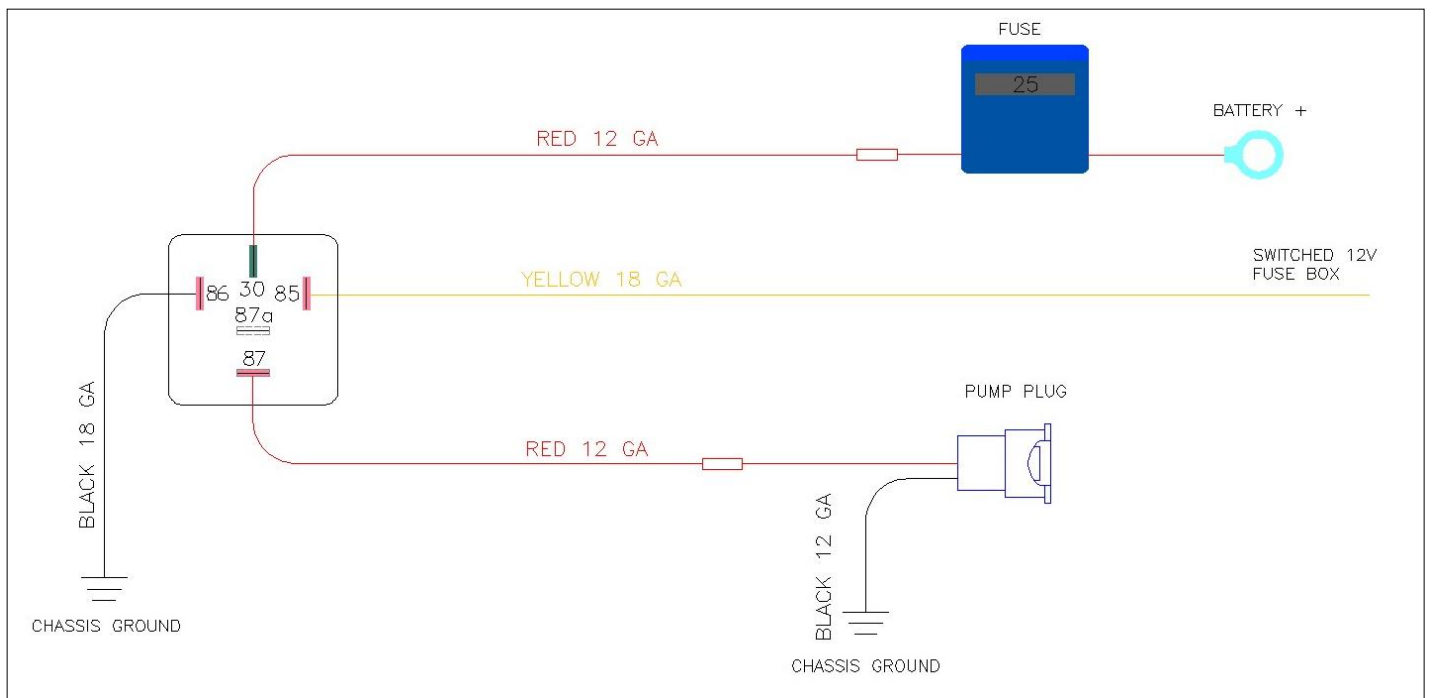

Photo 48



BYPASS VALVE / VACUUM LINES

1. Cut approx. 2 1/2" off of the straight end of the 1" hose. You will be using both pieces.

NOTE: This is already assembled for you.



Photo 49

2. Assemble the bypass valve and hose parts per picture and secure with hose clamps.



Photo 50

3. Attach the 90° end to the inlet boot and secure with a clamp. Route the supplied vacuum line from the bottom of the bypass valve through the opening in the timing case, to the vacuum fitting on the front runner. (See vacuum diagram on the next page) Leave the valve hanging there for now.



Photo 51

4. Using 2 5/8" hoses with the 90° ends, the 5/8" T fitting, and hose clamps, route the crankcase vent line from the passengers side, around the back of the engine, to the T fitting. Use a small cut off piece from the T to the drivers side valve cover and use the other 90° hose from the T fitting, under the blower to the fitting on the inlet boot. You will have to trim the hoses to the proper length.

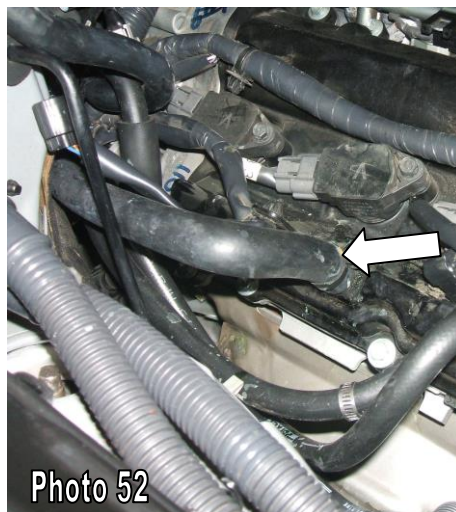

Photo 52

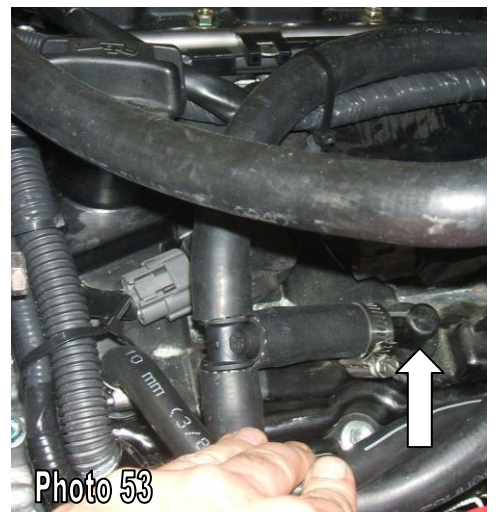
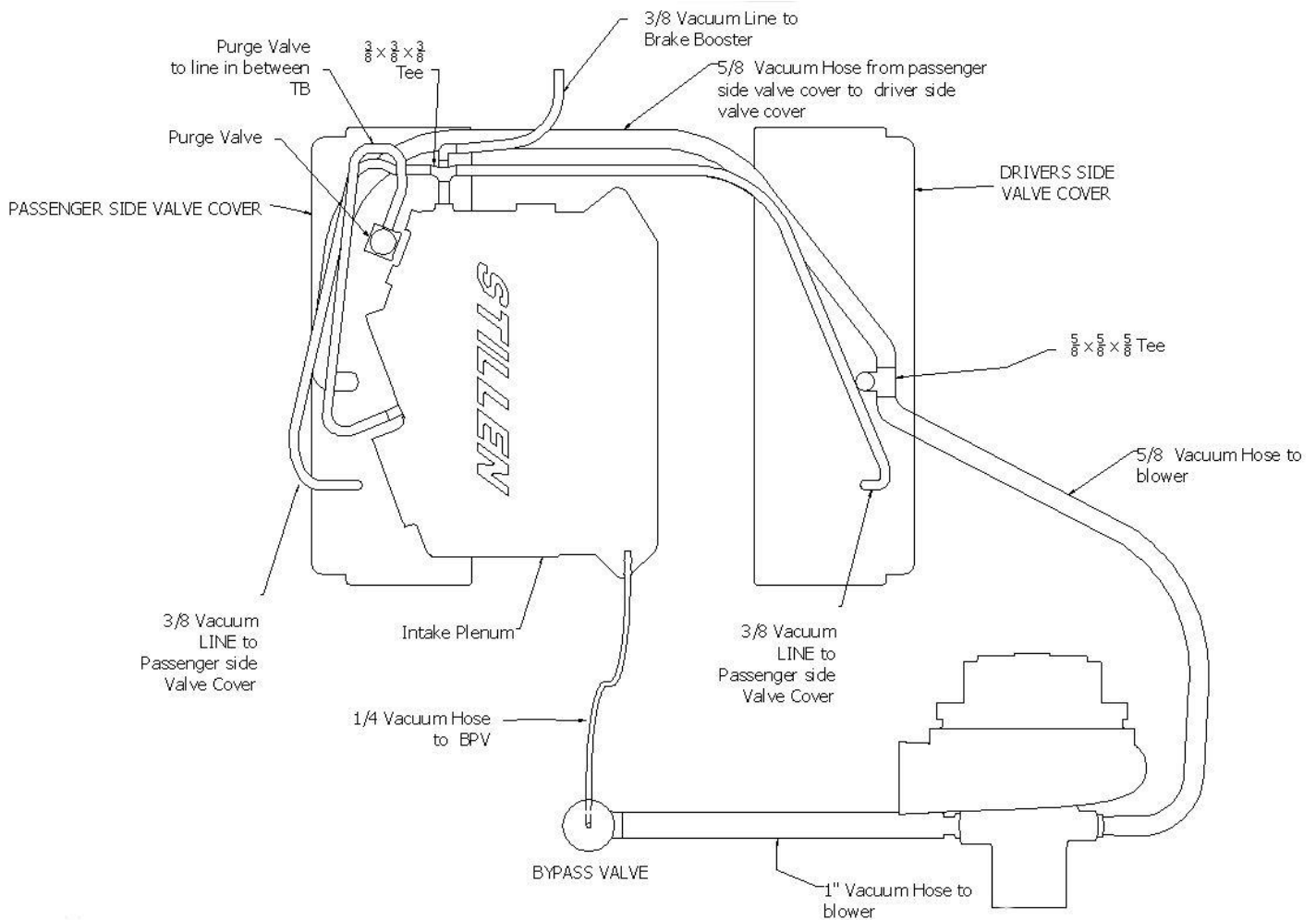
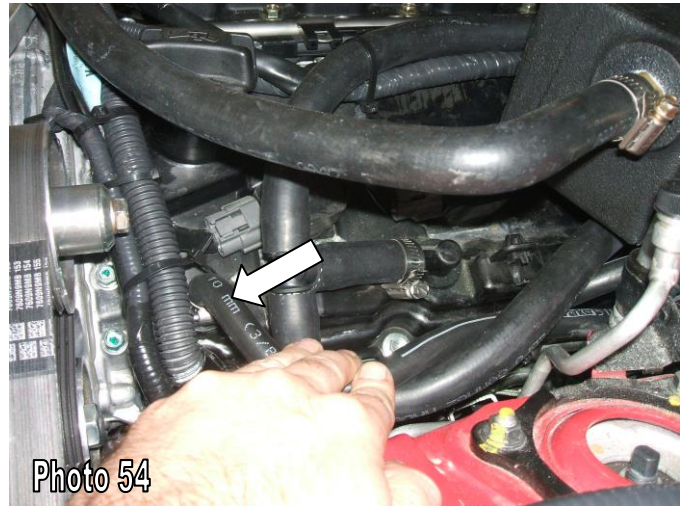

Photo 53

5. Using pieces of the 3/8" hose and clamps, route these lines from the PCV valves to the 3/8 x 3/8 x 3/8 tee which you will install on the straight fitting on the back of the manifold. (photo 54)
6. Using the 3/8" coupler, and provided 3/8" hose, extend and connect the brake booster line to the 90 elbow on the back of the manifold. You will be connecting the purge valve to the straight fitting in between the throttle bodies using the 1/4 id hose.



INLET INSTALLATION

1. Remove the hood latch support and replace with the supplied one. You will need to drill out the rivet in. You will need to move it around in order to line up the hole on the hood latch. (Photo 55)

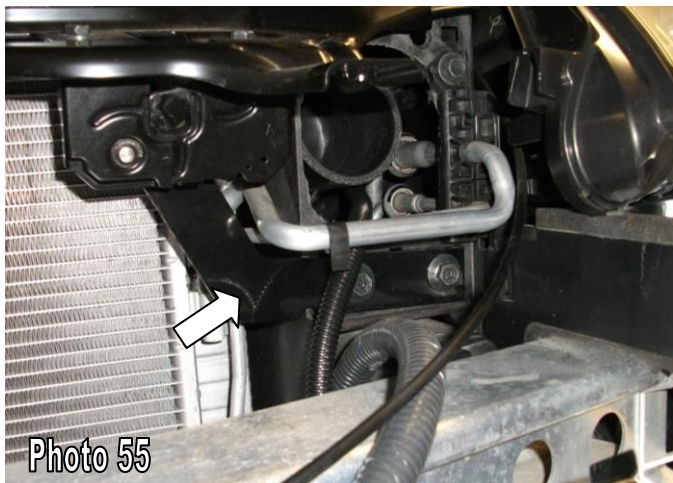

2. Install the filters onto the Y with the angles as in photo 56.
3. Transfer the MAF sensors from the stock intakes into the new Y. Check to make sure the seals that are on the base of the MAFs stay in place.



4. Install the step boot onto the Y. Insert the short end of the elbow into the boot and secure with clamps. Do not tighten the clamps very tight yet, as you will need to move the parts around to get them in place.



5. Slip a #40 clamp through the hole that was widened at the beginning of the install, and over the inlet boot. You will want the screw on the clamp pointing up on the drivers side so you can reach it through the holes in the core support. (photo 58)



6. Slide the loosely assembled Y into the inlet boot.
7. Adjust the Y until it is behind the bumper and tighten all the clamps.

IMPORTANT: When attaching the reducer, make sure the Y and elbow are not inserted too far. If the tubes are inserted past the flat sections on the reducer, the step may create turbulence. (photo 58A) ***Make sure the Y is in a straight line with the elbow.***

8. Install the MAF extension harnesses. They are approximately 43" in length. Beginning on the driver's side, connect to the factory MAF connection, ensuring the connector is fully seated and locked into position. Route through the radiator support (it is recommended to follow the intercooler hose routing). Secure the harness so that it will not contact any sharp metal edges, the heat exchanger or radiator. Repeat procedure for passenger side MAF..
9. Plug in the MAF sensors.
10. Install the air deflector/splash shield using the 3 self drilling screws.

NOTE: The air deflector/splash shield is designed to prevent inconsistent MAF readings and A/F ratios. It **MUST** be installed or drivability issues will result.

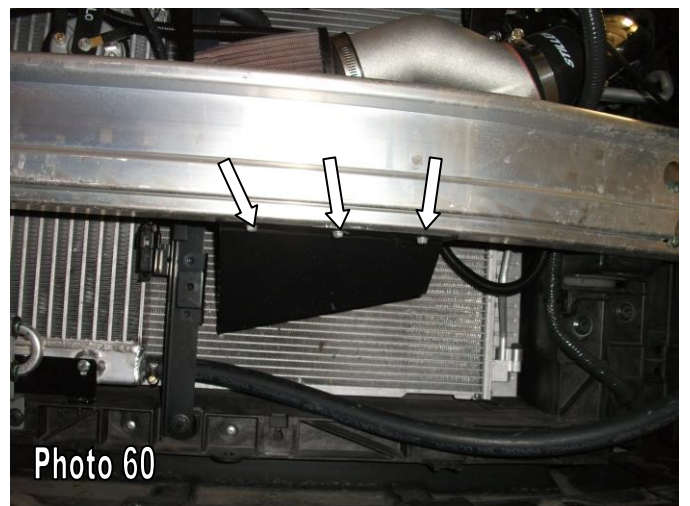
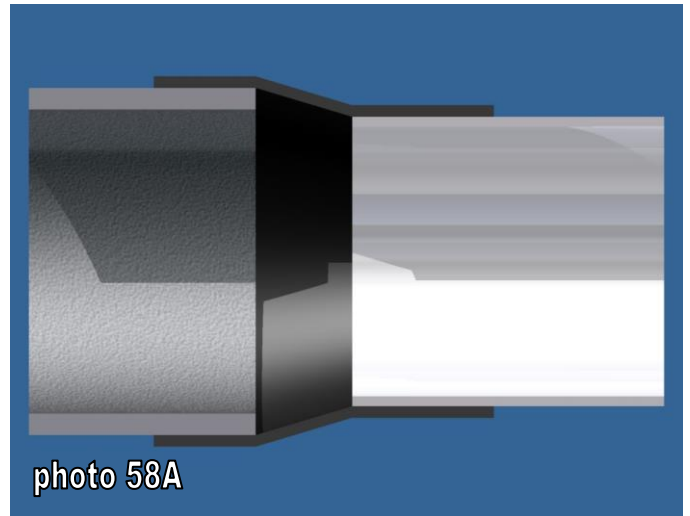

CHARGE PIPE INSTALLATION

1. Slide the 2 short boots onto the throttle body ends of the tube, the longer one onto the supercharger end, and slide them down
2. Attach the bypass valve to the fitting on the bottom of the inlet pipe and secure with a clamp.
3. Install the pipe and slide the 3 boots onto the throttle bodies and blower. Secure with the clamps.
4. Reinstall your strut tower bar placing the provided spacers under the ends of the bar.

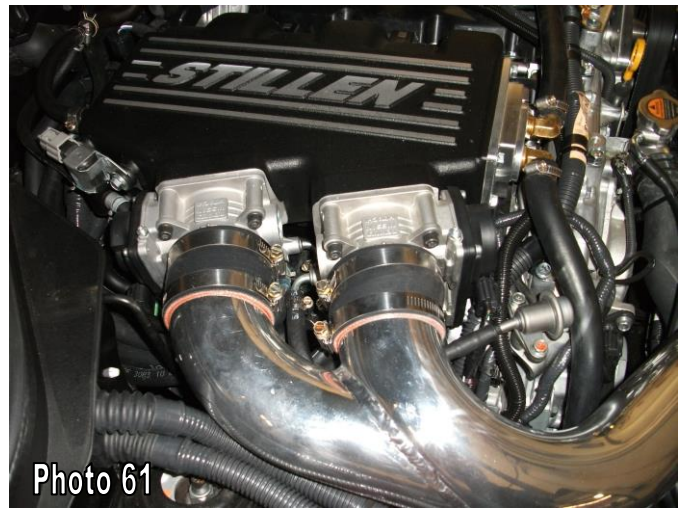

ECU REFLASH

Follow the instructions provided with the ECU tuning cable and software.



FINAL CHECK

1. Attached to the supercharger is an instruction tag and brass vent fitting. Follow these instructions for installing this vent plug in place of the shipping plug on the blower.
2. Check the oil level of the supercharger. It is shipped pre-oiled, however it is best to check the level before running.
3. Check for any unplugged vacuum lines or connectors.
4. Look around the belts to check for any wires or vacuum lines that may touch the belts. Secure everything clear of the belts and pulleys using zip ties. If zip tying vacuum lines, be sure not to pull the ties too tight and pinch off the lines.
5. Top off any coolant lost from the cooling system and fill the radiator overflow tank to the fill line.
6. Fill the intercooler system.

NOTE: If you live in a climate that sees freezing temperatures, you should fill the system with a 50/50 antifreeze/water mixture for winter. If you do not have freezing temperatures or for summer use, mix 1 cup Water Wetter™ with water in the system.

7. Reconnect the battery. Turn on the ignition, but do not start the car. The intercooler pump should start up. Fill the system as the air bleeds out. Do not let the pump suck in air as it may create an airlock. If this happens, disconnect the water line from the end of the tank, hold a finger over the fitting, and blow into the tank. This will force the water down into the pump and will release the airlock. The water level in the tank should be up to the base of the filler neck. Check the system for leaks.
8. Reinstall the fascia, battery and brake master cylinder cover.

EXTREMELY IMPORTANT:

To insure maximum performance and safety, boost pressure **MUST** be checked immediately after install. We recommend using a **quality** (Snap-On, AEM, HKS etc) calibrated boost/pressure gauge that reads 10-15psi (1 BAR) maximum if analog or a digital gauge. The gauge must be **"T"**eed into the small front vacuum line that leads to the supercharger bypass valve. Maximum boost reading will be obtained at WOT in 3rd gear @ 7000 rpm. We suggest you avoid hitting the RPM limiter or an incorrect reading will result. A dynamometer can be used if traffic conditions or an "off road" location is not available for proper testing.

The boost reading should be from 7.6-8.4 psi. Pressure can vary due to atmospheric conditions and dyno types. For example a Dynojet dyno boost reading will be .3-.4 low as compared to actual road testing. Make sure to do 2-3 tests and write down your results to confirm an accurate reading. If outside the recommended pressure readings please contact Stillen technical support immediately for further assistance

Notice to Installer:

It is important to give the section of these instructions titled "Care and Maintenance" to the owner of the vehicle.

CARE & MAINTENANCE

The STILLEN supercharger is designed to provide power AND reliability. All bearings used are lubricated and sealed. However there are some basic care items that should be checked regularly.

- Always use the best fuel available for your vehicle. **MINIMUM OF 91 OCTANE.**
- Check the oil in your supercharger every **2,500** miles. The initial fluid change should be done **2,500** miles after install and then every **7,500** miles
- **IF FOR WHATEVER REASON THE VEHICLE STARTS TO PING OR DETONATE UNDER LOAD OR HIGH RPM GET OFF THE THROTTLE!**
- Changing climate, altitude or atmospheric conditions will affect your vehicle. Various types of fuel (e.g. oxygenated, ethanol, etc) will also affect the performance of your vehicle.
- Check the supercharger drive belts regularly. Replace any that show signs of cracking/tearing.
- Check coolant level in intercooler often. It should be changed annually to maintain peak performance. Remember to use antifreeze if you live in an area that sees freezing conditions.
- Check your air filter regularly. A clogged air filter can drastically affect your vehicle. Clean and oil your air filter when it becomes dirty. **DO NOT OVER OIL.**
- High quality synthetic oil is recommended and oil changes should be done every 3,000 miles. This improves engine durability and longevity in a forced induction application.
- Do **not** alter, modify or adjust the Stillen supercharger system in any way. Unauthorized changes to boost levels, electronics, tuning or any other system will **void** warranties and can cause catastrophic engine damage.

SUPERCHARGER ASSEMBLY

SUPERCHARGER ASSEMBLY

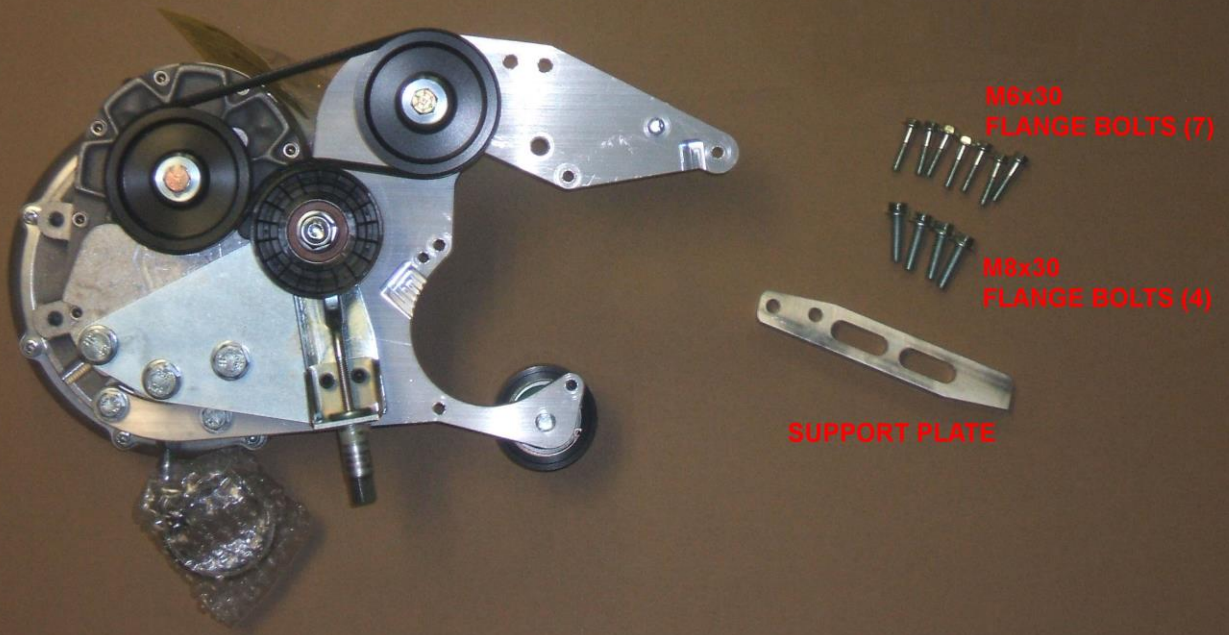

M6x30
FLANGE BOLTS (7)

M8x30
FLANGE BOLTS (4)

SUPPORT PLATE

IDLER ASSEMBLY

IDLER ASSEMBLY



M10
WASHER

M10x110 HHCS

M6x45 FLANGE BOLT

M6x35 FLANGE BOLT

MANIFOLD ASSEMBLY

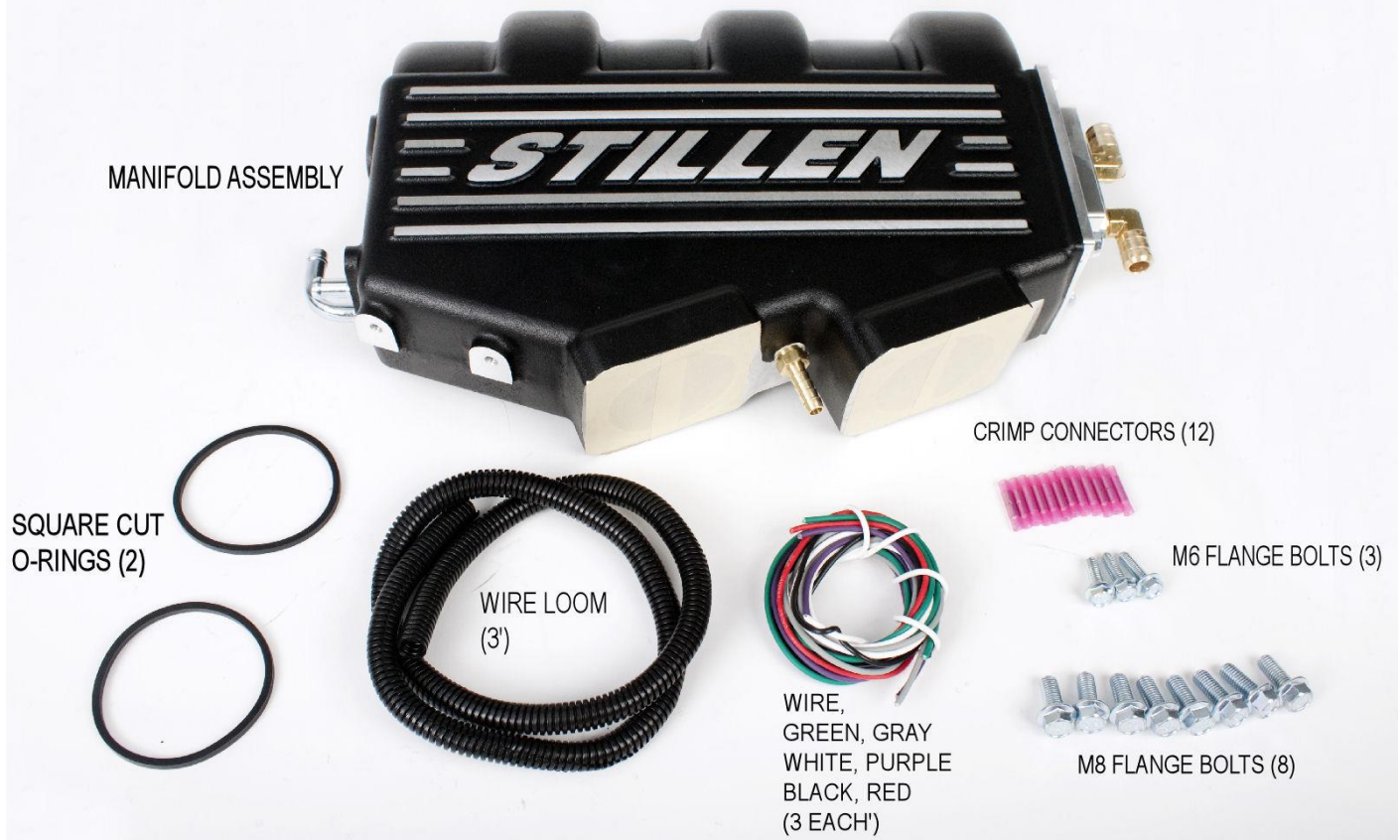

INLET TRACT 1

SPLASH SHIELD

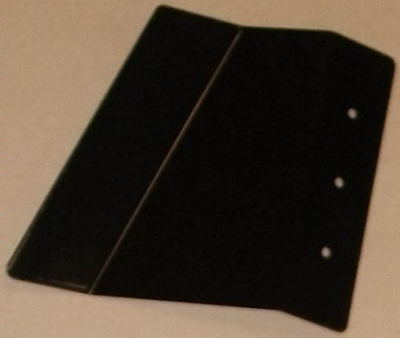

FILTERS & INLET Y



3" LONG SILICONE BOOT



SILICONE REDUCER



SHORT INLET TUBE



LONG INLET TUBE

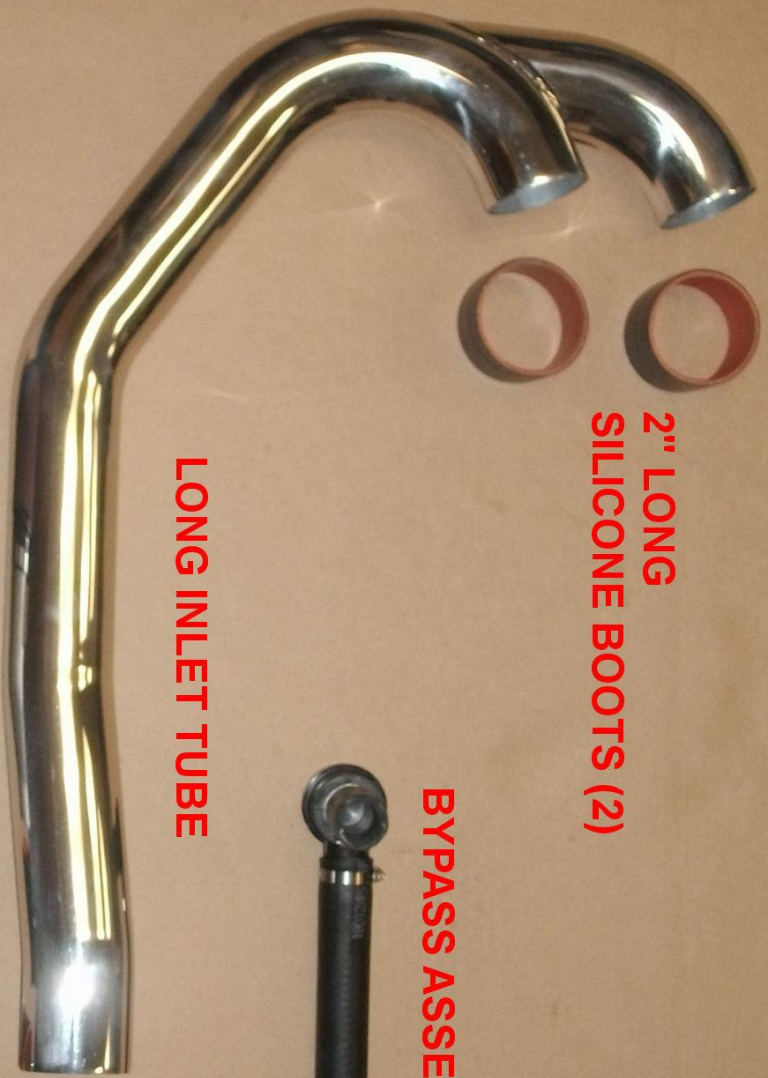

2" LONG SILICONE BOOTS (2)



BYPASS ASSEMBLY



SILICONE INLET BOOT ASSEMBLY



INLET TRACT 2

TB AND MAF EXTENSION
HARNESSES



SELF DRILLING SCREWS
(FOR SPLASH SHIELD) (3)



5/32 VAC LINE
(FOR BYPASS VALVE) (2')



#16 (2)



#12 (7)



#56



#48



#40 (2)



#44 (6)



HOSE CLAMPS

HOSE, 3/8 (14')



HOSE, 5/8, 90 DEGREE (2)



HOSE, 5/16 (1')



REDUCER TEE



5/8 TEE



#12 HOSE
CLAMPS (3)



#4 HOSE
CLAMPS (13)



INTERCOOLER SYSTEM



FUEL SYSTEM

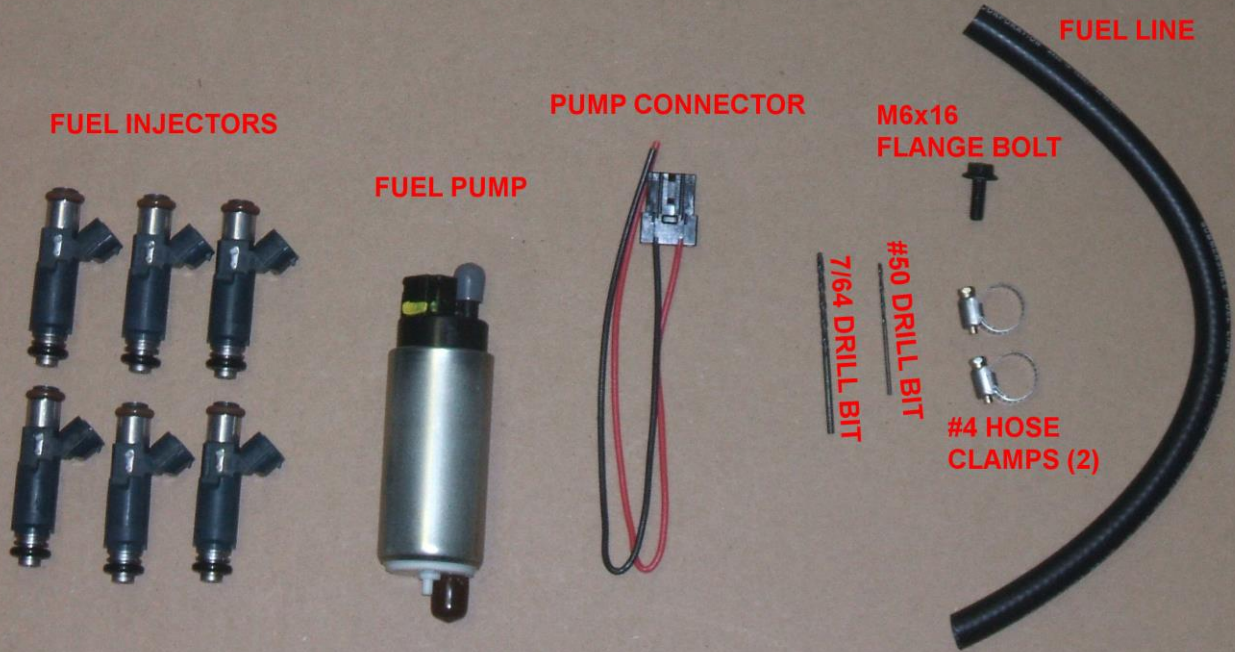

MISC PARTS

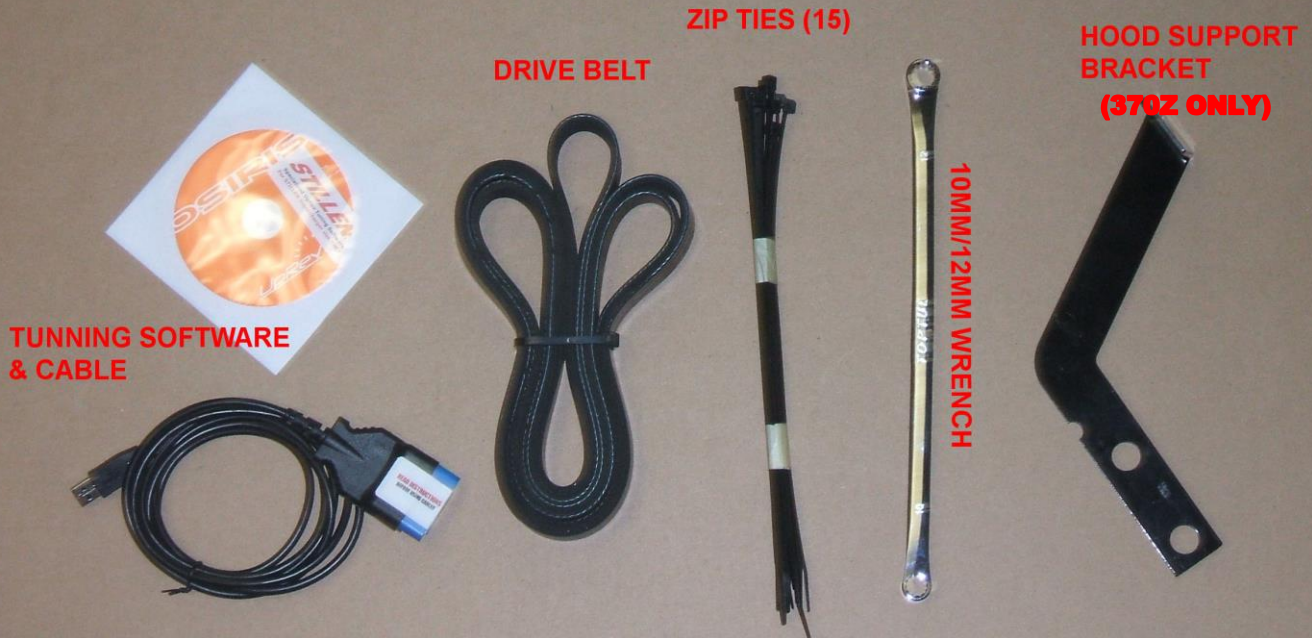

Engine Cover Supplement Instructions

1. You will be installing the engine cover brackets where shown in **(Fig.1)** The taller one will go on the rear fuel rail bolt and the shorter one will be installed on the front 2 bolts which are holding on the support brace. See **(Fig.2)** You will be reusing the existing bolts already in place. For the front bracket it is recommended to loosen the bolts which secure the grounds onto the drive plate support.

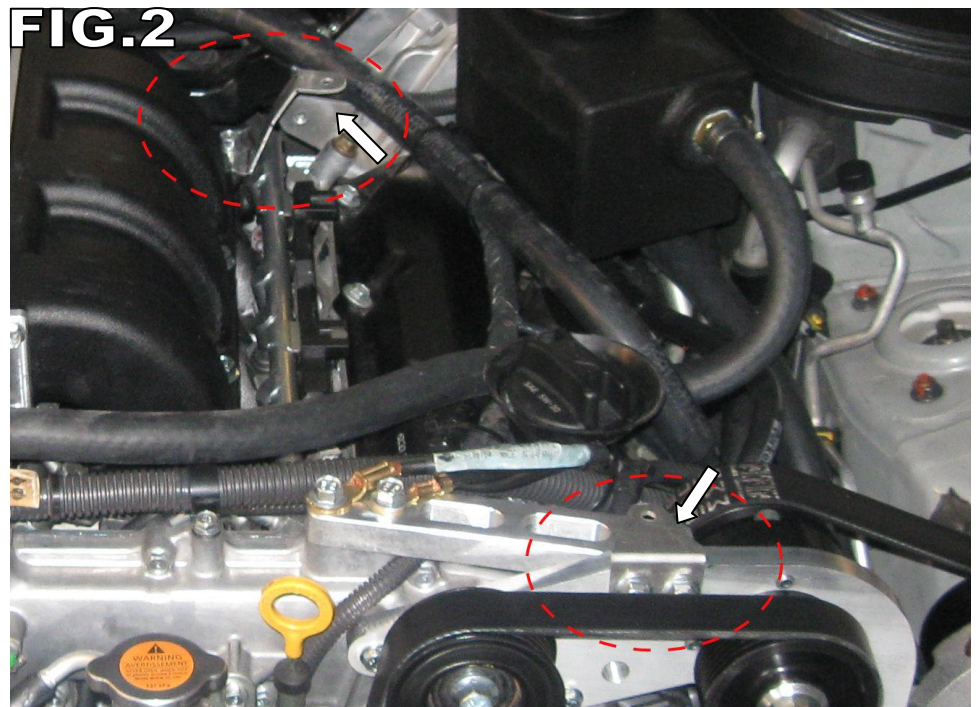
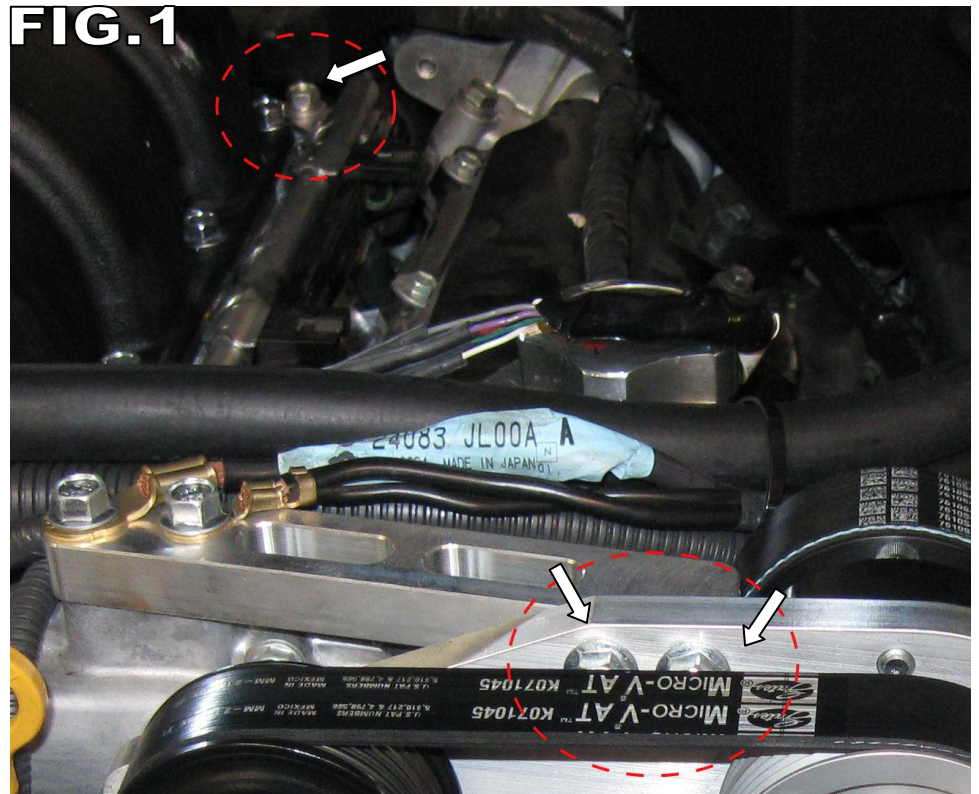

2. Once installed you will install the engine cover using the supplied BHCS bolts and nuts. See (Fig.3)

